

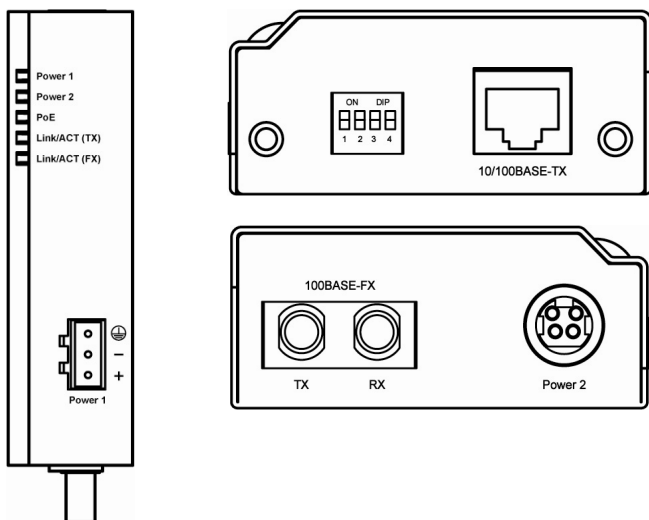

Quick Start Guide

This quick start guide describes how to install and use the Industrial PoE Media Converter. This is the Media Converter of choice for harsh environments constrained by space.

Physical Description

The Terminal Block and Power inputs



Power Input Assignment (15.4W IEEE802.3af PoE model)			
Power 1 (48VDC)	+	48VDC	Terminal Block
	-	Power Ground	
Power 1 (-48VDC)	+	RTN	
	-	-48VDC	
		Earth Ground	
Power 2		48VDC	DC Jack

Power Input Assignment (30W High Power PoE model)			
Power 1	+	48~52VDC for 15.4W 52~57VDC for 30W	Terminal Block
	-	Power Ground	
		Earth Ground	
Power 2		48~52VDC for 15.4W 52~57VDC for 30W	DC Jack

DC Power Inputs: There are two power inputs that can be used to power up this Industrial PoE Media Converter. Redundant power supplies function is supported.

The DIP Switch

DIP Switch	On	Off
1	Enable forced mode for TX port	Enable auto negotiation for TX port
2	TX port forced to 10Mbps	TX port forced to 100Mbps
3	TX port forced to half duplex mode	TX port forced to full duplex mode
4	Enable Link-Fault-Pass-Through	Disable Link-Fault-Pass-Through

The 10/100Base-TX and 100Base-FX/BX Connectors

1. The 10/100Base-TX Connections

The following lists the pinouts of 10/100Base-TX ports.

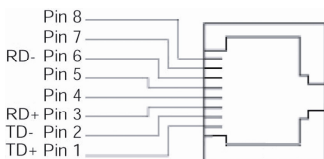

Pin	Regular Ports	Uplink Port
1	Output Transmit Data +	Input Receive Data +
2	Output Transmit Data -	Input Receive Data -
3	Input Receive Data +	Output Transmit Data +
4	NC	NC
5	NC	NC
6	Input Receive Data -	Output Transmit Data -
7	NC	NC
8	NC	NC

2. The 100Base-FX Connections

The fiber port pinouts: The Tx (transmit) port of device I is connected to the Rx (receive) port of device II, and the Rx (receive) port of device I to the Tx (transmit) port of device II.

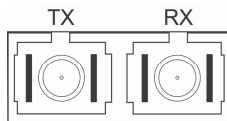

3. The WDM 100Base-BX Connections

The fiber port pinouts: Only one single-mode optical fiber is required to transmit and receive data.

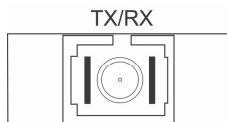

The Port Status LEDs

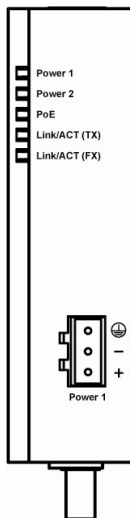

LED	State	Indication
Power over Ethernet (PoE)		
PoE	Steady	Power Device (PD) is connected.
	Off	Power Device (PD) is disconnected.
10/100Base-TX, 100Base-FX/BX		
Link/ACT	Steady	A valid network connection established.
	Flashing	Transmitting or receiving data. ACT stands for ACTIVITY.

DIN-Rail Kits, Optional Wall Mounting Kits

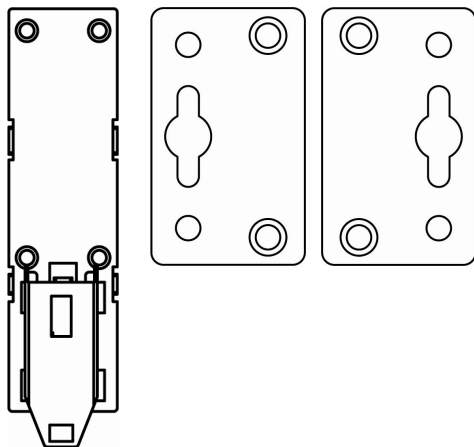

Functional Description

- Meets EN61000-6-2 & EN61000-6-4 EMC Generic Standard Immunity for industrial environment.
- Supports IEEE802.3af Power over Ethernet (PoE) Power Sourcing Equipment (PSE) or supports 30W High Power PoE Power Sourcing Equipment (PSE).

- DIP Switch configuration for “Link-Fault-Pass-Through”, speed, duplex mode.
- Supports IEEE802.3/802.3u/802.3x. Auto-negotiation: 10/100Mbps, Full/Half-duplex, Auto-Negotiation, Auto MDI/MDIX.
- 100Base-FX: Multi/Single mode SC or ST type, 100Base-BX: WDM Multi/Single mode SC type.
- Supports 1024 MAC addresses. Provides 2.25M bits buffer memory.
- Power Supplies: Redundant 48VDC or -48VDC Terminal Block power input and 48VDC DC JACK with 100-240VAC external power supply.
- Field Wiring Terminal Markings: Use Copper Conductors Only, 60/75°C, wire range 12-24 AWG, torque value 7 lb-in.
- Operating voltage and Max. current consumption: 0.075A @ 48VDC. Power consumption: 3.6W Max.
- 15.4W IEEE802.3af PoE model:
 - Redundant 48VDC or -48VDC Terminal Block power input and 48VDC DC JACK.
 - Operating voltage and Max. current consumption when PoE link with 15.4W IEEE802.3af PD: 0.4A @ 48VDC or -0.4A @ -48VDC. Power consumption: 19.2W Max.
- 30W High Power PoE model:
 - Supports up to 15.4W: Redundant 48 to 52VDC Terminal Block power input and 48 to 52VDC DC JACK.
 - Operating voltage and Max. current consumption when PoE link with 15.4W IEEE802.3af PD: 0.4A @ 48VDC. Power consumption: 19.2W Max.
 - Supports up to 30W: Redundant 52 to 57VDC Terminal Block power input and 52 to 57VDC DC JACK.
 - Operating voltage and Max. current consumption when PoE link with 30W High Power PD: 0.62A @ 55VDC. Power consumption: 34.1W Max.

- -10°C to 60°C (14°F to 140°F) operating temperature range. UL508 Industrial Control Equipment certified Maximum Surrounding Air Temperature @ 60°C (140°F).
- For use in Pollution Degree 2 Environment.
- Supports DIN-Rail, Panel, or Wall Mounting installation.

Assembly, Startup, and Dismantling

- **Assembly:** Place the Media Converter on the DIN rail from above using the slot. Push the front of the Media Converter toward the mounting surface until it audibly snaps into place.
- **Startup:** Connect the supply voltage to start up the Media Converter via the terminal block (or DC JACK).
- **Dismantling:** Pull out the lower edge and then remove the Media Converter from the DIN rail.

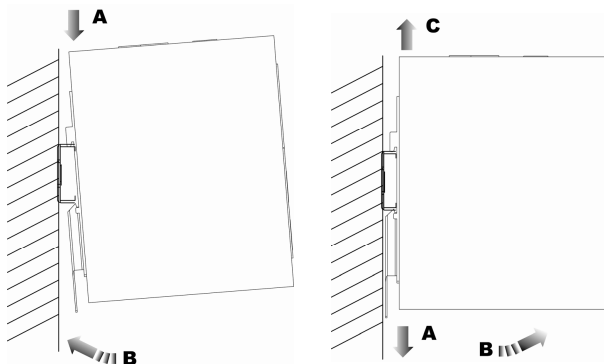

Preface

A member of the growing family of Industrial Media Converters, this Industrial PoE Media Converter addresses a need for a Power over Ethernet (PoE) Media Converter. Capable of operating at temperature extremes of -10°C to $+60^{\circ}\text{C}$, this is the Media Converter of choice for harsh environments.

15.4W IEEE802.3af PoE model:

The 10/100Base-TX port on this Media Converter supports IEEE802.3af Power over Ethernet (PoE) Power Sourcing Equipment (PSE) and can detect an IEEE802.3af compliant Powered Device (PD). Using external 48 or -48VDC power inputs through Terminal Block or 48VDC Power Jack, data and power can be transmitted to a Powered Device (PD) over the same twisted-pair Ethernet cable through 10/100Base-TX port on the Media Converter.

30W High Power PoE model:

The 10/100Base-TX port on this Media Converter supports IEEE802.3af Power over Ethernet (PoE) Power Sourcing Equipment (PSE) and can detect an IEEE802.3af compliant Powered Device (PD). Using external 48~52VDC power inputs through Terminal Block or Power Jack, data and power can be transmitted to a Powered Device (PD) over the same twisted-pair Ethernet cable through 10/100Base-TX port on the Media Converter.

Or the 10/100Base-TX port on this Media Converter supports 30W High Power PoE Power Sourcing Equipment (PSE) and can detect a 30W High Power PoE compliant Powered Device (PD). Using external 52~57VDC power inputs through Terminal Block or Power Jack, data and power can be transmitted to a Powered Device (PD) over the same twisted-pair Ethernet cable through 10/100Base-TX port on the Media Converter.

This manual describes how to install and use the Industrial PoE Media Converter. This Media Converter integrates full wire speed switching technology. And this Media Converter brings the answer to complicated hardened networking environments.

To get the most out of this manual, you should have an understanding of Ethernet networking concepts.

In this manual, you will find:

- Features on the Media Converter
- Illustrative LED functions
- Installation instructions
- Specifications

Table of Contents

QUICK START GUIDE	1
PHYSICAL DESCRIPTION	1
<i>The Terminal Block and Power inputs</i>	1
<i>The DIP Switch</i>	2
<i>The 10/100Base-TX and 100Base-FX/BX Connectors</i>	2
<i>The Port Status LEDs</i>	3
<i>DIN-Rail Kits, Optional Wall Mounting Kits</i>	4
FUNCTIONAL DESCRIPTION	4
ASSEMBLY, STARTUP, AND DISMANTLING	6
PREFACE	7
TABLE OF CONTENTS	9
PRODUCT OVERVIEW	10
INDUSTRIAL PoE MEDIA CONVERTER	10
PACKAGE CONTENTS	10
PRODUCT HIGHLIGHTS	11
<i>Basic Features</i>	11
FRONT PANEL DISPLAY	12
PHYSICAL PORTS	14
INSTALLATION	15
SELECTING A SITE FOR THE MEDIA CONVERTER	15
WIRING DIAGRAM	16
DIN RAIL MOUNTING	16
CONNECTING TO POWER	17
<i>DC Terminal Block Power Input</i>	17
<i>DC Jack</i>	17
DIP SWITCH	19
CONNECTING TO YOUR NETWORK	19
<i>Cable Type & Length</i>	19
<i>Cabling</i>	20
SPECIFICATIONS	21

Product Overview

Industrial PoE Media Converter

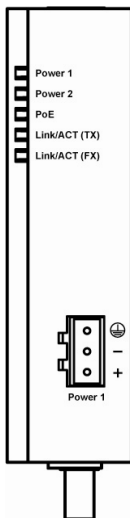

Package Contents

When you unpack the product package, you shall find the items listed below. Please inspect the contents, and report any apparent damage or missing items immediately to your authorized reseller.

- ✓ ***This Media Converter***
- ✓ ***User's Manual***
- ✓ ***External power adapter & Power Cord (Optional)***

Product Highlights

Basic Features

- Meets EN61000-6-2 & EN61000-6-4 EMC Generic Standard Immunity for industrial environment.
- Supports IEEE802.3af Power over Ethernet (PoE) Power Sourcing Equipment (PSE) or supports 30W High Power PoE Power Sourcing Equipment (PSE).
- DIP Switch configuration for “Link-Fault-Pass-Through”, speed, duplex mode.
- Supports IEEE802.3/802.3u/802.3x. Auto-negotiation: 10/100Mbps, Full/Half-duplex, Auto-Negotiation, Auto MDI/MDIX.
- 100Base-FX: Multi/Single mode SC or ST type, 100Base-BX: WDM Multi/Single mode SC type.
- Supports 1024 MAC addresses. Provides 2.25M bits buffer memory.
- Power Supplies: Redundant 48VDC or -48VDC Terminal Block power input and 48VDC DC JACK with 100-240VAC external power supply.
- Field Wiring Terminal Markings: Use Copper Conductors Only, 60/75°C, wire range 12-24 AWG, torque value 7 lb-in.
- Operating voltage and Max. current consumption: 0.075A @ 48VDC. Power consumption: 3.6W Max.
- 15.4W IEEE802.3af PoE model:
 - Redundant 48VDC or -48VDC Terminal Block power input and 48VDC DC JACK.
 - Operating voltage and Max. current consumption when PoE link with 15.4W IEEE802.3af PD: 0.4A @ 48VDC or -0.4A @ -48VDC. Power consumption: 19.2W Max.
- 30W High Power PoE model:
 - Supports up to 15.4W: Redundant 48 to 52VDC Terminal Block power input and 48 to 52VDC DC JACK.

- Operating voltage and Max. current consumption when PoE link with 15.4W IEEE802.3af PD: 0.4A @ 48VDC. Power consumption: 19.2W Max.
- Supports up to 30W: Redundant 52 to 57VDC Terminal Block power input and 52 to 57VDC DC JACK.
- Operating voltage and Max. current consumption when PoE link with 30W High Power PD: 0.62A @ 55VDC. Power consumption: 34.1W Max.
- For use in Pollution Degree 2 Environment.
- Supports DIN-Rail, Panel, or Wall Mounting installation.

Front Panel Display

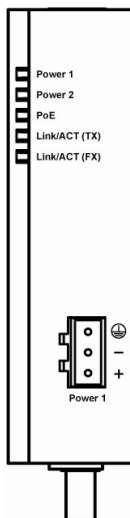

Status LEDs

LED	State	Indication
Power over Ethernet (PoE)		
PoE	Steady	Power Device (PD) is connected.
	Off	Power Device (PD) is disconnected.
10/100Base-TX, 100Base-FX/BX		
Link/ACT	Steady	A valid network connection established.
	Flashing	Transmitting or receiving data. ACT stands for ACTIVITY.

Physical Ports

This Media Converter provides:

One 10/100Base-TX port + one 100Base-FX/BX port

CONNECTIVITY

- RJ-45 connectors
- SC or ST connector on 100Base-FX fiber port.
- SC connector on 100Base-BX fiber port.

Installation

This chapter gives step-by-step instructions about how to install the Media Converter:

Selecting a Site for the Media Converter

As with any electric device, you should place the Media Converter where it will not be subjected to extreme temperatures, humidity, or electromagnetic interference. Specifically, the site you select should meet the following requirements:

- The ambient temperature should be between -10 to 60 degrees Celsius.
- The relative humidity should be less than 95 percent, non-condensing.
- Surrounding electrical devices should not exceed the electromagnetic field (RFC) standards.
- Make sure that the Media Converter receives adequate ventilation. Do not block the ventilation holes on each side of the Media Converter.
- The power outlet should be within 1.8 meters of the Media Converter.

Wiring Diagram

Field Wiring Terminal Markings: Use Copper Conductors Only, 60/75°C, wire range 12-24 AWG, torque value 7 lb-in.

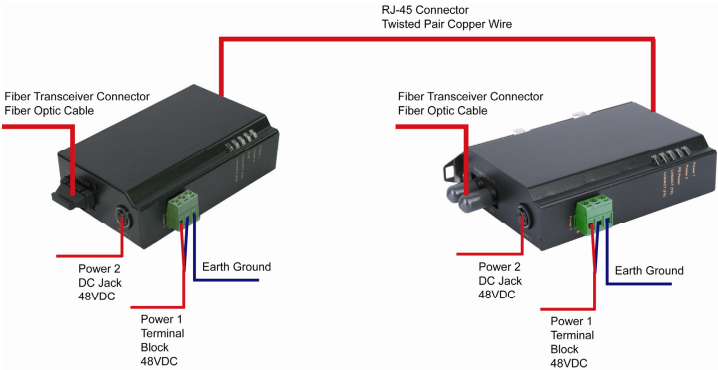

DIN Rail Mounting

- Fix the DIN rail attachment plate to the back panel of the Media Converter.
- Installation: Place the Media Converter on the DIN rail from above using the slot. Push the front of the Media Converter toward the mounting surface until it audibly snaps into place.
- Removal: Pull out the lower edge and then remove the Media Converter from the DIN rail.

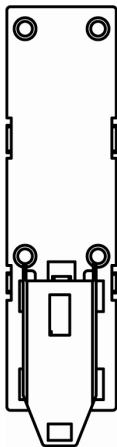

Connecting to Power

Redundant DC Terminal Block Power Input and DC Jack:

DC Terminal Block Power Input

- Step 1:** Connect the DC power cord to the plug-able terminal block on the Media Converter, and then plug it into a standard DC outlet.
- Step 2:** Disconnect the power cord if you want to shut down the Media Converter.

DC Jack

- Step 1:** Connect the supplied AC to DC power adapter to the receptacle on the Media Converter.
- Step 2:** Connect the power cord to the AC to DC power adapter and attach the plug into a standard AC outlet with the appropriate AC voltage.

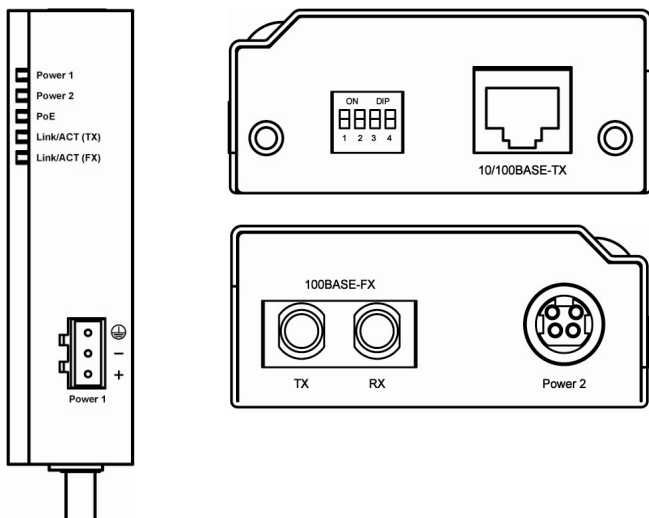

Power Input Assignment (15.4W IEEE802.3af PoE model)			
Power 1 (48VDC)	+	48VDC	Terminal Block
	-	Power Ground	
Power 1 (-48VDC)	+	RTN	
	-	-48VDC	
		Earth Ground	
Power 2		48VDC	DC Jack

Power Input Assignment (30W High Power PoE model)			
Power 1	+	48~52VDC for 15.4W 52~57VDC for 30W	Terminal Block
	-	Power Ground	
		Earth Ground	
Power 2		48~52VDC for 15.4W 52~57VDC for 30W	DC Jack

DIP Switch

There are four pins on the DIP switch for port settings. Refer to the table below for more details.

DIP Switch	On	Off
1	Enable forced mode for TX port	Enable auto negotiation for TX port
2	TX port forced to 10Mbps	TX port forced to 100Mbps
3	TX port forced to half duplex mode	TX port forced to full duplex mode
4	Enable Link-Fault-Pass-Through	Disable Link-Fault-Pass-Through

Connecting to Your Network

Cable Type & Length

It is necessary to follow the cable specifications below when connecting the Media Converter to your network. Use appropriate cables that meet your speed and cabling requirements.

Cable Specifications

Speed	Connector	Port Speed Half/Full Duplex	Cable	Max. Distance
10Base-T	RJ-45	10/20 Mbps	2-pair UTP/STP Cat. 3, 4, 5	100 m
100Base-TX	RJ-45	100/200 Mbps	2-pair UTP/STP Cat. 5	100 m
100Base-FX	SC, ST	200 Mbps	MMF (50 or 62.5µm)	2 km
100Base-FX	SC, ST	200 Mbps	SMF (9 or 10µm)	20, 40, or 75 km
100Base-BX	SC	200 Mbps	MMF (50 or 62.5µm)	2 or 5 km
100Base-FX	SC	200 Mbps	SMF (9 or 10µm)	20 or 40 km

Cabling

Step 1: First, ensure the power of the Media Converter and end devices are turned off.

<Note> Always ensure that the power is off before any installation.

Step 2: Prepare cable with corresponding connectors for each type of port in use.

Step 3: Consult the previous section for cabling requirements based on connectors and speed.

Step 4: Connect one end of the cable to the Media Converter and the other end to a desired device.

Step 5: Once the connections between two end devices are made successfully, turn on the power and the Media Converter is operational.

Specifications

Industrial PoE Media Converter	10/100Base-TX auto-negotiating port with RJ-45 connector, 100Base-FX/BX fiber port
Applicable Standards	IEEE 802.3 10Base-T IEEE 802.3u 100Base-TX/FX
Switching Method	Store-and-Forward
Forwarding Rate	
10Base-T:	10 / 20Mbps half / full-duplex
100Base-TX:	100 / 200Mbps half / full-duplex
100Base-FX/BX:	200Mbps full-duplex
Performance	14,880pps for 10Mbps 148,810pps for 100Mbps
Cable	
10Base-T:	4-pair UTP/STP Cat. 3, 4, 5
100Base-TX:	4-pair UTP/STP Cat. 5 Up to 100m (328ft)
100Base-FX/BX:	MMF (50 or 62.5 μ m), SMF (9 or 10 μ m)
LED Indicators	Per unit – Power status (Power 1, Power 2) PoE status (PoE) Per port – 10/100TX or 100FX/BX - Link/ACT
Dimensions	70mm (W) \times 110mm (D) \times 30mm (H) (2.76" (W) \times 4.33" (D) \times 1.18" (H))
Net Weight	0.25Kg (0.55lb.)
Power Consumption	3.6W Max.
Operating Voltage & Max. Current Consumption	0.075A @ 48VDC
15.4W IEEE802.3af PoE model	
Power	Terminal Block: 48VDC, -48VDC DC Jack: 48VDC, External AC/DC required
Operating Voltage & Max. Current Consumption	0.4A @ 48VDC or -0.4A @ -48VDC
Power Consumption	19.2W Max.
30W High Power PoE model	
Power	Supports up to 15.4W: 48~52VDC Supports up to 30W: 52~57VDC
Operating Voltage & Max. Current Consumption	When PoE link with 15.4W IEEE802.3af PD: 0.4A @ 48VDC When PoE link with 30W High Power PD: 0.62A @ 55VDC

Industrial PoE Media Converter

Power Consumption	When PoE link with 15.4W IEEE802.3af PD: 19.2W Max. When PoE link with 30W High Power PD: 34.1W Max.
Operating Temperature	-10°C to 60°C (14°F to 140°F)
Storage Temperature	-40°C to 85°C (-40°F to 185°F)
Humidity	5%-95% non-condensing
Safety	UL508

EMI

FCC Part 15, Class A

VCCI Class A

EN61000-6-4:

EN55022

EN61000-3-2

EN61000-3-3

EMS

EN61000-6-2:

EN61000-4-2 (ESD Standard)

EN61000-4-3 (Radiated FRI Standards)

EN61000-4-4 (Burst Standards)

EN61000-4-5 (Surge Standards)

EN61000-4-6 (Induced RFI Standards)

EN61000-4-8 (Magnetic Field Standards)

Environmental Test Compliance

IEC60068-2-6 Fc (Vibration Resistance)

IEC60068-2-27 Ea (Shock)

IEC60068-2-32 Ed (Free Fall)